



NATIONAL POWER CORPORATION

MinGen

BIDDING DOCUMENTS

FOR

**CONSTRUCTION OF PUMPHOUSE & SUPPLY OF
FIRE HYDRANT AND FIRE FIGHTING SYSTEM**

PR No.: MG-ST523-011

**Procurement Services Section
Logistics Division**

**Sixth Edition
July 2020
*Rev. 3***

Table of Contents

Glossary of Acronyms, Terms, and Abbreviations	2
Section I. Invitation to Bid.....	5
Section II. Instructions to Bidders.....	9
1. Scope of Bid	10
2. Funding Information.....	10
3. Bidding Requirements	10
4. Corrupt, Fraudulent, Collusive, and Coercive Practices	10
5. Eligible Bidders.....	11
6. Origin of Goods	11
7. Subcontracts	11
8. Pre-Bid Conference	11
9. Clarification and Amendment of Bidding Documents	11
10. Documents comprising the Bid: Eligibility and Technical Components	12
11. Documents comprising the Bid: Financial Component	12
12. Bid Prices	12
13. Bid and Payment Currencies	13
14. Bid Security	13
15. Sealing and Marking of Bids	13
16. Deadline for Submission of Bids	14
17. Opening and Preliminary Examination of Bids	14
18. Domestic Preference	14
19. Detailed Evaluation and Comparison of Bids	14
20. Post-Qualification	15
21. Signing of the Contract.....	15
Section III. Bid Data Sheet	16
Section IV. General Conditions of Contract.....	19
1. Scope of Contract	20
2. Advance Payment and Terms of Payment	20
3. Performance Security	20
4. Inspection and Tests	20
5. Warranty	21
6. Liability of the Supplier	21
Section V. Special Conditions of Contract	22
Section VI. Schedule of Requirements	27
Section VII. Technical Specifications	28
Section VIII. Checklist of Technical and Financial Documents and Bidding Forms.....	36

Glossary of Acronyms, Terms, and Abbreviations

ABC – Approved Budget for the Contract.

BAC – Bids and Awards Committee.

Bid – A signed offer or proposal to undertake a contract submitted by a bidder in response to and in consonance with the requirements of the bidding documents. Also referred to as *Proposal and Tender*. (2016 revised IRR, Section 5[c])

Bidder – Refers to a contractor, manufacturer, supplier, distributor and/or consultant who submits a bid in response to the requirements of the Bidding Documents. (2016 revised IRR, Section 5[d])

Bidding Documents – The documents issued by the Procuring Entity as the bases for bids, furnishing all information necessary for a prospective bidder to prepare a bid for the Goods, Infrastructure Projects, and/or Consulting Services required by the Procuring Entity. (2016 revised IRR, Section 5[e])

BIR – Bureau of Internal Revenue.

BSP – Bangko Sentral ng Pilipinas.

Consulting Services – Refer to services for Infrastructure Projects and other types of projects or activities of the GOP requiring adequate external technical and professional expertise that are beyond the capability and/or capacity of the GOP to undertake such as, but not limited to: (i) advisory and review services; (ii) pre-investment or feasibility studies; (iii) design; (iv) construction supervision; (v) management and related services; and (vi) other technical services or special studies. (2016 revised IRR, Section 5[i])

CDA - Cooperative Development Authority.

Contract – Refers to the agreement entered into between the Procuring Entity and the Supplier or Manufacturer or Distributor or Service Provider for procurement of Goods and Services; Contractor for Procurement of Infrastructure Projects; or Consultant or Consulting Firm for Procurement of Consulting Services; as the case may be, as recorded in the Contract Form signed by the parties, including all attachments and appendices thereto and all documents incorporated by reference therein.

CIF – Cost Insurance and Freight.

CP – Carriage and Insurance Paid.

CPI – Consumer Price Index.

DDP – Refers to the quoted price of the Goods, which means “delivered duty paid.”

DTI – Department of Trade and Industry.

EXW – Ex works.

FCA – “Free Carrier” shipping point.

FOB – “Free on Board” shipping point.

Foreign-funded Procurement or Foreign-Assisted Project–Refers to procurement whose funding source is from a foreign government, foreign or international financing institution as specified in the Treaty or International or Executive Agreement. (2016 revised IRR, Section 5[b]).

Framework Agreement – Refers to a written agreement between a procuring entity and a supplier or service provider that identifies the terms and conditions, under which specific purchases, otherwise known as “Call-Offs,” are made for the duration of the agreement. It is in the nature of an option contract between the procuring entity and the bidder(s) granting the procuring entity the option to either place an order for any of the goods or services identified in the Framework Agreement List or not buy at all, within a minimum period of one (1) year to a maximum period of three (3) years. (GPPB Resolution No. 27-2019)

GFI – Government Financial Institution.

GOCC –Government-owned and/or –controlled corporation.

Goods – Refer to all items, supplies, materials and general support services, except Consulting Services and Infrastructure Projects, which may be needed in the transaction of public businesses or in the pursuit of any government undertaking, project or activity, whether in the nature of equipment, furniture, stationery, materials for construction, or personal property of any kind, including non-personal or contractual services such as the repair and maintenance of equipment and furniture, as well as trucking, hauling, janitorial, security, and related or analogous services, as well as procurement of materials and supplies provided by the Procuring Entity for such services. The term “related” or “analogous services” shall include, but is not limited to, lease or purchase of office space, media advertisements, health maintenance services, and other services essential to the operation of the Procuring Entity. (2016 revised IRR, Section 5[r])

GOP – Government of the Philippines.

GPPB – Government Procurement Policy Board.

INCOTERMS – International Commercial Terms.

Infrastructure Projects – Include the construction, improvement, rehabilitation, demolition, repair, restoration or maintenance of roads and bridges, railways, airports, seaports, communication facilities, civil works components of information technology projects, irrigation, flood control and drainage, water supply, sanitation, sewerage and solid waste management systems, shore protection, energy/power and electrification facilities, national

buildings, school buildings, hospital buildings, and other related construction projects of the government. Also referred to as *civil works or works*. (2016 revised IRR, Section 5[u])

LGUs – Local Government Units.

NFCC – Net Financial Contracting Capacity.

NGA – National Government Agency.

PhilGEPS - Philippine Government Electronic Procurement System.

Procurement Project – refers to a specific or identified procurement covering goods, infrastructure project or consulting services. A Procurement Project shall be described, detailed, and scheduled in the Project Procurement Management Plan prepared by the agency which shall be consolidated in the procuring entity's Annual Procurement Plan. (GPPB Circular No. 06-2019 dated 17 July 2019)

PSA – Philippine Statistics Authority.

SEC – Securities and Exchange Commission.

SLCC – Single Largest Completed Contract.

Supplier – refers to a citizen, or any corporate body or commercial company duly organized and registered under the laws where it is established, habitually established in business and engaged in the manufacture or sale of the merchandise or performance of the general services covered by his bid. (Item 3.8 of GPPB Resolution No. 13-2019, dated 23 May 2019). Supplier as used in these Bidding Documents may likewise refer to a distributor, manufacturer, contractor, or consultant.

UN – United Nations.

Section I

Invitation to Bid





NATIONAL POWER CORPORATION

MinGen

INVITATION TO BID FOR CONSTRUCTION OF PUMPHOUSE & SUPPLY OF FIRE HYDRANT AND FIRE FIGHTING SYSTEM

1. The *NATIONAL POWER CORPORATION- MINDANAO GENERATION*, through the *CORPORATE BUDGET OF NPC* intends to apply the sum of *Two Million Pesos (PHP2,000,000.00)* only being the ABC to payments under the contract for *PR No.MG-ST23-011*. Bids received in excess of the ABC shall be automatically rejected at bid opening.
2. The *NATIONAL POWER CORPORATION- MINDANAO GENERATION* now invites bids for the above Procurement Project. Delivery of the Goods is required *Ninety (90) Calendar Days from the receipt of Notice to Proceed*. Bidders should have completed, within *five (5) years* from the date of submission and receipt of bids, a contract similar to the Project. The description of an eligible bidder is contained in the Bidding Documents, particularly, in Section II (Instructions to Bidders).
3. Bidding will be conducted through open competitive bidding procedures using a non-discretionary "*pass/fail*" criterion as specified in the 2016 revised Implementing Rules and Regulations (IRR) of Republic Act (RA) No. 9184.
 - a. Bidding is open to all interested bidders, whether local or foreign, subject to the conditions for eligibility provided in the 2016 revised IRR of RA No. 9184.
4. Prospective Bidders may obtain further information from *NATIONAL POWER CORPORATION- MINDANAO GENERATION* and inspect the Bidding Documents at the address given below during *8:00 AM – 5:00 PM, Monday to Friday*.
5. A complete set of Bidding Documents may be acquired by interested Bidders on *25 June – 18 July 2023* from the given address and website(s) below and upon payment of the applicable fee for the Bidding Documents, pursuant to the latest Guidelines issued by the GPPB, in the amount of *Three Thousand Pesos (PHP3,000.00) only*. The Procuring Entity shall allow the bidder to pay online and present its proof of payment for the fees *in person, by facsimile, or through electronic means*. *For those prospective bidders who wish to pay online, below are the details of the account:*

LandbankAccount name : NPC GENCO 5 COLLECTIONS FUND
LandbankAccount number : 0321-1689-14

SECTION I- INVITATION TO BID

PR NO./REF. NO.MG-ST23-011

It may also be downloaded free of charge from the website of the Philippine Government Electronic Procurement System (PhilGEPS) provided that Bidders shall pay the applicable fee for the Bidding Documents not later than the submission of their bids.

6. The *NATIONAL POWER CORPORATION- MINDANAO GENERATION* will hold a Pre-Bid Conference¹ on 04 July 2023, 9:00AM at BAC-Bidding Room, MINGEN Headquarters, NPC, Maria Cristina, Iligan City and/or through video conferencing or webcasting via Zoom, which shall be open to prospective bidders. Interested online attendees are required to pre-register one (1) day before the scheduled pre-bidding conference. For pre-registration, contact tel. no. (063)-223-4604 or email logistics_afd_mingen@napocor.gov.ph.
7. Bids must be duly received by the BAC Secretariat through manual submission at the office address indicated below, on or before 18 July 2023, 9:30AM. Late bids shall not be accepted.
8. All Bids must be accompanied by a bid security in any of the acceptable forms and in the amount stated in ITB Clause 14.
9. Bid opening shall be on 18 July 2023, 9:30AM at Bidding Room, Mindanao Generation Headquarters, Maria Cristina, Iligan City. Bids will be opened in the presence of the bidders' representatives who choose to attend the activity.
10. *THE NECESSARY FEATURES OF THE PROJECT TO BE PROCURED:*
 - a. Supply, Installation, Testing and Commissioning of one (1) unit Diesel Fire Pump (62KW Engine, 4 Cylinder).
 - b. Supply, Installation, interconnection of 3Ø inch Sched 40 B.I. pipe
 - c. Construction of Diesel Fire Pump foundation and pumphouse.
11. The *NATIONAL POWER CORPORATION- MINDANAO GENERATION* reserves the right to reject any and all bids, declare a failure of bidding, or not award the contract at any time prior to contract award in accordance with Sections 35.6 and 41 of the 2016 revised IRR of RA No. 9184, without thereby incurring any liability to the affected bidder or bidders.
12. For further information, please refer to:

*BAC Secretariat
Procurement Services Section
Logistics Division
MinGen Headquarters
National Power Corporation
Maria Cristina, Iligan City
logistics_afd_mingen@napocor.gov.ph
Tel./Fax: (063) 223-4604/223-8355*

¹ May be deleted in case the ABC is less than One Million Pesos (PhP1,000,000) where the Procuring Entity may not hold a Pre-Bid Conference.

BID DOCUMENTS

NAME OF PROJECT: CONSTRUCTION OF PUMPHOUSE AND
SUPPLY OF FIRE HYDRANT &
FIREFIGHTING SYSTEM

SECTION I- INVITATION TO BID

PR NO./REF. NO.MG-ST23-011

[\[www.napocor.gov.ph\]](http://www.napocor.gov.ph)

13. You may visit the following websites:

For downloading of Bidding Documents: <https://www.philgeps.gov.ph/> and
www.napocor.gov.ph.

25 June 2023

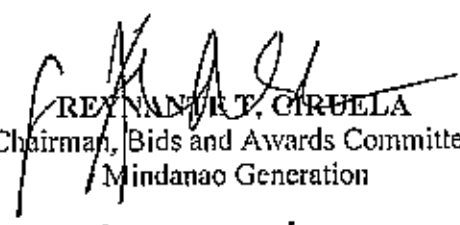
REYNANIRT, CIRUELA
Chairman, Bids and Awards Committee
Mindanao Generation

Section II

Instructions to Bidders

1. Scope of Bid

The Procuring Entity, *NATIONAL POWER CORPORATION – MINDANAO GENERATION* wishes to receive Bids for the **CONSTRUCTION OF PUMPHOUSE & SUPPLY OF FIRE HYDRANT AND FIRE FIGHTING SYSTEM** with identification number *MG-ST523-011*.

The Procurement Project (referred to herein as "Project") is composed of *One (1) lot*, the details of which are described in Section VII (Technical Specifications).

2. Funding Information

2.1. The GOP through the source of funding as indicated below for *2023 Budget* in the amount of *PHP 2,000,000.00*.

2.2. The source of funding is:

GOCC and GFIs, the proposed Corporate Operating Budget.

3. Bidding Requirements

The Bidding for the Project shall be governed by all the provisions of RA No. 9184 and its 2016 revised IRR, including its Generic Procurement Manuals and associated policies, rules and regulations as the primary source thereof, while the herein clauses shall serve as the secondary source thereof.

Any amendments made to the IRR and other GPPB issuances shall be applicable only to the ongoing posting, advertisement, or IB by the BAC through the issuance of a supplemental or bid bulletin.

The Bidder, by the act of submitting its Bid, shall be deemed to have verified and accepted the general requirements of this Project, including other factors that may affect the cost, duration and execution or implementation of the contract, project, or work and examine all instructions, forms, terms, and project requirements in the Bidding Documents.

4. Corrupt, Fraudulent, Collusive, and Coercive Practices

The Procuring Entity, as well as the Bidders and Suppliers, shall observe the highest standard of ethics during the procurement and execution of the contract. They or through an agent shall not engage in corrupt, fraudulent, collusive, coercive, and obstructive practices defined under Annex "I" of the 2016 revised IRR of RA No. 9184 or other integrity violations in competing for the Project.

5. Eligible Bidders

- 5.1. Only Bids of Bidders found to be legally, technically, and financially capable will be evaluated.
- 5.2. Foreign ownership limited to those allowed under the rules may participate in this Project.
- 5.3. Pursuant to Section 23.4.1.3 of the 2016 revised IRR of RA No.9184, the Bidder shall have an SLCC that is at least one (1) contract similar to the Project the value of which, adjusted to current prices using the PSA's CPI, must be at least equivalent to:

For the procurement of Non-expendable Supplies and Services: The Bidder must have completed a single contract that is similar to this Project, equivalent to at least fifty percent (50%) of the ABC.

- 5.4. The Bidders shall comply with the eligibility criteria under Section 23.4.1 of the 2016 IRR of RA No. 9184.

6. Origin of Goods

There is no restriction on the origin of goods other than those prohibited by a decision of the UN Security Council taken under Chapter VII of the Charter of the UN, subject to Domestic Preference requirements under ITB Clause 18.

7. Subcontracts

- 7.1. The Bidder may subcontract portions of the Project to the extent allowed by the Procuring Entity as stated herein, but in no case more than twenty percent (20%) of the Project.

The Procuring Entity has prescribed that:

- a. Subcontracting is not allowed.

8. Pre-Bid Conference

The Procuring Entity will hold a pre-bid conference for this Project on the specified date and time and either at its physical address and/or through videoconferencing/webcasting} as indicated in paragraph 6 of the IB.

9. Clarification and Amendment of Bidding Documents

Prospective bidders may request for clarification on and/or interpretation of any part of the Bidding Documents. Such requests must be in writing and received by the Procuring Entity, either at its given address or through electronic mail indicated in the

IB, at least ten (10) calendar days before the deadline set for the submission and receipt of Bids.

10. Documents comprising the Bid: Eligibility and Technical Components

- 10.1. The first envelope shall contain the eligibility and technical documents of the Bid as specified in Section VIII (Checklist of Technical and Financial Documents).
- 10.2. The Bidder's SLCC as indicated in ITB Clause 5.3 should have been completed within *the last five (5) years* prior to the deadline for the submission and receipt of bids.
- 10.3. If the eligibility requirements or statements, the bids, and all other documents for submission to the BAC are in foreign language other than English, it must be accompanied by a translation in English, which shall be authenticated by the appropriate Philippine foreign service establishment, post, or the equivalent office having jurisdiction over the foreign bidder's affairs in the Philippines. Similar to the required authentication above, for Contracting Parties to the Apostille Convention, only the translated documents shall be authenticated through an Apostille pursuant to GPPB Resolution No. 13-2019 dated 23 May 2019. The English translation shall govern, for purposes of interpretation of the bid.

11. Documents comprising the Bid: Financial Component

- 11.1. The second bid envelope shall contain the financial documents for the Bid as specified in Section VIII (Checklist of Technical and Financial Documents).
- 11.2. If the Bidder claims preference as a Domestic Bidder or Domestic Entity, a certification issued by DTI shall be provided by the Bidder in accordance with Section 43.1.3 of the 2016 revised IRR of RA No. 9184.
- 11.3. Any bid exceeding the ABC indicated in paragraph 1 of the IB shall not be accepted.
- 11.4. For Foreign-funded Procurement, a ceiling may be applied to bid prices provided the conditions are met under Section 31.2 of the 2016 revised IRR of RA No. 9184.

12. Bid Prices

- 12.1. Prices indicated on the Price Schedule shall be entered separately in the following manner:
 - a. For Goods offered from within the Procuring Entity's country:
 - i. The price of the Goods quoted EXW (ex-works, ex-factory, ex-warehouse, ex-showroom, or off-the-shelf, as applicable);

- ii. The cost of all customs duties and sales and other taxes already paid or payable;
 - iii. The cost of transportation, insurance, and other costs incidental to delivery of the Goods to their final destination; and
 - iv. The price of other (incidental) services, if any, listed in e.
- b. For Goods offered from abroad:
- i. Unless otherwise stated in the BDS, the price of the Goods shall be quoted delivered duty paid (DDP) with the place of destination in the Philippines as specified in the BDS. In quoting the price, the Bidder shall be free to use transportation through carriers registered in any eligible country. Similarly, the Bidder may obtain insurance services from any eligible source country.
 - ii. The price of other (incidental) services, if any, as listed in Section VII (Technical Specifications).

13. Bid and Payment Currencies

13.1. For Goods that the Bidder will supply from outside the Philippines, the bid prices may be quoted in the local currency or tradeable currency accepted by the BSP at the discretion of the Bidder. However, for purposes of bid evaluation, Bids denominated in foreign currencies, shall be converted to Philippine currency based on the exchange rate as published in the BSP reference rate bulletin on the day of the bid opening.

13.2. Payment of the contract price shall be made in:

- a. Philippine Pesos.

14. Bid Security

14.1. The Bidder shall submit a Bid Securing Declaration² or any form of Bid Security in the amount indicated in the BDS, which shall be not less than the percentage of the ABC in accordance with the schedule in the BDS.

14.2. The Bid and bid security shall be valid until *One Hundred Twenty (120) Days from the Date of Scheduled Bid Opening*. Any Bid not accompanied by an acceptable bid security shall be rejected by the Procuring Entity as non-responsive.

15. Sealing and Marking of Bids

² In the case of Framework Agreement, the undertaking shall refer to entering into contract with the Procuring Entity and furnishing of the performance security or the performance securing declaration within ten (10) calendar days from receipt of Notice to Execute Framework Agreement.

SECTION II- INSTRUCTION TO BIDDERS

PR NO./REF. NO.MG-STS23-011

Each Bidder shall submit one copy of the first and second components of its Bid.

The Procuring Entity may request additional hard copies and/or electronic copies of the Bid. However, failure of the Bidders to comply with the said request shall not be a ground for disqualification.

If the Procuring Entity allows the submission of bids through online submission or any other electronic means, the Bidder shall submit an electronic copy of its Bid,

which must be digitally signed. An electronic copy that cannot be opened or is corrupted shall be considered non-responsive and, thus, automatically disqualified.

16. Deadline for Submission of Bids

16.1. The Bidders shall submit on the specified date and time and either at its physical address or through online submission as indicated in paragraph 7 of the IB.

17. Opening and Preliminary Examination of Bids

17.1. The BAC shall open the Bids in public at the time, on the date, and at the place specified in paragraph 9 of the IB. The Bidders' representatives who are present shall sign a register evidencing their attendance. In case videoconferencing, webcasting or other similar technologies will be used, attendance of participants shall likewise be recorded by the BAC Secretariat.

In case the Bids cannot be opened as scheduled due to justifiable reasons, the rescheduling requirements under Section 29 of the 2016 revised IRR of RA No. 9184 shall prevail.

17.2. The preliminary examination of bids shall be governed by Section 30 of the 2016 revised IRR of RA No. 9184.

18. Domestic Preference

18.1. The Procuring Entity will grant a margin of preference for the purpose of comparison of Bids in accordance with Section 43.1.2 of the 2016 revised IRR of RA No. 9184.

19. Detailed Evaluation and Comparison of Bids

19.1. The Procuring BAC shall immediately conduct a detailed evaluation of all Bids rated "*passed*," using non-discretionary pass/fail criteria. The BAC shall consider the conditions in the evaluation of Bids under Section 32.2 of the 2016 revised IRR of RA No. 9184.

19.2. If the Project allows partial bids, bidders may submit a proposal on any of the lots or items, and evaluation will be undertaken on a per lot or item basis, as

SECTION II- INSTRUCTION TO BIDDERS

PR NO./REF. NO.MG-STS23-011

the case maybe. In this case, the Bid Security as required by ITB Clause 15 shall be submitted for each lot or item separately.

19.3. The descriptions of the lots or items shall be indicated in Section VII (Technical Specifications), although the ABCs of these lots or items are indicated in the BDS for purposes of the NFCC computation pursuant to Section 23.4.2.6 of the 2016 revised IRR of RA No. 9184. The NFCC must be sufficient for the total of the ABCs for all the lots or items participated in by the prospective Bidder.

19.4. The Project shall be awarded as follows:

One Project having several items that shall be awarded as one contract.

19.5. Except for bidders submitting a committed Line of Credit from a Universal or Commercial Bank in lieu of its NFCC computation, all Bids must include the NFCC computation pursuant to Section 23.4.1.4 of the 2016 revised IRR of RA No. 9184, which must be sufficient for the total of the ABCs for all the lots or items participated in by the prospective Bidder. For bidders submitting the committed Line of Credit, it must be at least equal to ten percent (10%) of the ABCs for all the lots or items participated in by the prospective Bidder.

20. Post-Qualification

20.1. For multi-year Framework Agreement, all bidders initially determined to be eligible and financially compliant shall be subject to initial post-qualification. The BAC shall then recommend the execution of a Framework Agreement among all eligible, technically and financially compliant bidders and the Procuring Entity and shall be issued by HOPE a Notice to Execute Framework Agreement. The determination of the Lowest Calculated Bid (LCB) shall not be performed by the BAC until a Mini-Competition is conducted among the bidders who executed a Framework Agreement. When a Call for Mini-Competition is made, the BAC shall allow the bidders to submit their best financial proposals on such pre-scheduled date, time and place to determine the bidder with the LCB.

20.2. Within a non-extendible period of five (5) calendar days from receipt by the Bidder of the notice from the BAC that it submitted the Lowest Calculated Bid, the Bidder shall submit its latest income and business tax returns filed and paid through the BIR Electronic Filing and Payment System (EFPS) and other appropriate licenses and permits required by law and stated in the BDS.

21. Signing of the Contract

21.1. The documents required in Section 37.2 of the 2016 revised IRR of RA No. 9184 shall form part of the Contract. Additional Contract documents are indicated in the BDS.

Section III
Bid Data Sheet

Bid Data Sheet

ITB Clause	
5.3	<p>For this purpose, contracts similar to the Project shall be:</p> <ol style="list-style-type: none"> a. <i>Supply, Installation, Testing and Commissioning of Firefighting Equipment</i> b. Completed within [the last Five (5) years] prior to the deadline for the submission and receipt of bids.
7.1	Subcontracting is not allowed.
12	The price of the Goods shall be quoted DDP <i>MinGenHeadquarter, Maria Cristina, Iligan City, Lanao Del Norte</i> or the applicable International Commercial Terms (INCOTERMS) for this Project.
14.1	<p>The bid security shall be in the form of a Bid Securing Declaration, or any of the following forms and amounts:</p> <ol style="list-style-type: none"> a. The amount of not less than <i>Forty Thousand Pesos (PHP40,000.00) only, 2% of ABC</i>, if bid security is in cash, cashier's/manager's check, bank draft/guarantee or irrevocable letter of credit; or b. The amount of not less than <i>One Hundred Thousand Pesos (PHP100,000.00) only, 5% of ABC</i> if bid security is in Surety Bond.
19.3	Partial bid is not allowed.
20.2	<p>Applicable documents to be presented/submitted during post-qualification:</p> <ol style="list-style-type: none"> 1. Original Valid and Updated PhilGEPS Registration Certificate (Platinum Membership) (all pages); 2. Registration certificate from Securities and Exchange Commission (SEC), Department of Trade and Industry (DTI) for sole proprietorship, or Cooperative Development Authority (CDA) for cooperatives or its equivalent document. 3. Mayor's or Business permit issued by the city or municipality where the principal place of business of the prospective bidder is located, or the equivalent document for Exclusive Economic Zones or Areas; 4. Tax clearance per E.O. No. 398, s. 2005, as finally reviewed and approved by the Bureau of Internal Revenue (BIR). 5. The Supplier's audited financial statements, showing, among others, the Supplier's total and current assets and liabilities, stamped "received" by the BIR or its duly accredited and authorized institutions, for the preceding calendar year which should not be earlier than two (2) years from the date of bid submission;

21.2	<i>[List here any additional contract documents relevant to the Project that may be required by existing laws and/or the Procuring Entity.]</i>
------	---

Section IV
General Conditions of Contract

1. Scope of Contract

This Contract shall include all such items, although not specifically mentioned, that can be reasonably inferred as being required for its completion as if such items were expressly mentioned herein. All the provisions of RA No. 9184 and its 2016 revised IRR, including the Generic Procurement Manual, and associated issuances, constitute the primary source for the terms and conditions of the Contract, and thus, applicable in contract implementation. Herein clauses shall serve as the secondary source for the terms and conditions of the Contract.

This is without prejudice to Sections 74.1 and 74.2 of the 2016 revised IRR of RA No. 9184 allowing the GPPB to amend the IRR, which shall be applied to all procurement activities, the advertisement, posting, or invitation of which were issued after the effectivity of the said amendment.

Additional requirements for the completion of this Contract shall be provided in the **Special Conditions of Contract (SCC)**.

2. Advance Payment and Terms of Payment

2.1. Advance payment of the contract amount is provided under Annex "D" of the revised 2016 IRR of RA No. 9184.

2.2. The Procuring Entity is allowed to determine the terms of payment on the partial or staggered delivery of the Goods procured, provided such partial payment shall correspond to the value of the goods delivered and accepted in accordance with prevailing accounting and auditing rules and regulations. The terms of payment are indicated in the **SCC**.

3. Performance Security

Within ten (10) calendar days from receipt of the Notice of Award by the Bidder from the Procuring Entity but in no case later than prior to the signing of the Contract by both parties, the successful Bidder shall furnish the performance security in any of the forms prescribed in Section 39 of the 2016 revised IRR of RA No. 9184.

4. Inspection and Tests

The Procuring Entity or its representative shall have the right to inspect and/or to test the Goods to confirm their conformity to the Project specifications at no extra cost to the Procuring Entity in accordance with the Generic Procurement Manual. In addition to tests in the **SCC**, **Section IV (Technical Specifications)** shall specify what inspections and/or tests the Procuring Entity requires, and where they are to be conducted. The Procuring Entity shall notify the Supplier in writing, in a timely manner, of the identity of any representatives retained for these purposes.

All reasonable facilities and assistance for the inspection and testing of Goods, including access to drawings and production data, shall be provided by the Supplier to the authorized inspectors at no charge to the Procuring Entity.

5. Warranty

- 6.1. In order to assure that manufacturing defects shall be corrected by the Supplier, a warranty shall be required from the Supplier as provided under Section 62.1 of the 2016 revised IRR of RA No. 9184.
- 6.2. The Procuring Entity shall promptly notify the Supplier in writing of any claims arising under this warranty. Upon receipt of such notice, the Supplier shall, repair or replace the defective Goods or parts thereof without cost to the Procuring Entity, pursuant to the Generic Procurement Manual.

6. Liability of the Supplier

The Supplier's liability under this Contract shall be as provided by the laws of the Republic of the Philippines.

If the Supplier is a joint venture, all partners to the joint venture shall be jointly and severally liable to the Procuring Entity.

Section V
Special Conditions of Contract

Special Conditions of Contract

GCC Clause	
1	<p>Delivery and Documents –</p> <p>For purposes of the Contract, “EXW,” “FOB,” “FCA,” “CIF,” “CIP,” “DDP” and other trade terms used to describe the obligations of the parties shall have the meanings assigned to them by the current edition of INCOTERMS published by the International Chamber of Commerce, Paris. The Delivery terms of this Contract shall be as follows:</p> <p><i>For Goods supplied from abroad, state:</i> “The delivery terms applicable to the Contract are DDP delivered Mindanao Generation (MinGen) Headquarters, Maria Cristina, Iligan City, Lanao del Norte. In accordance with INCOTERMS.”</p> <p><i>For Goods supplied from within the Philippines, state:</i> “The delivery terms applicable to this Contract are delivered Mindanao Generation (MinGen) Headquarters, Maria Cristina, Iligan City, Lanao del Norte. Risk and title will pass from the Supplier to the Procuring Entity upon receipt and final acceptance of the Goods at their final destination.”</p> <p>Delivery of the Goods shall be made by the Supplier in accordance with the terms specified in Section VI (Schedule of Requirements).</p> <p>For purposes of this Clause the Procuring Entity’s Representative at the Project Site is <i>RONAN P. MAGDUGO</i></p> <p>Incidental Services –</p> <p>The Supplier is required to provide all of the following services, including additional services, if any, specified in Section VI. Schedule of Requirements:</p> <ol style="list-style-type: none"> a. performance or supervision of on-site assembly and/or start-up of the supplied Goods; b. furnishing of tools required for assembly and/or maintenance of the supplied Goods; c. furnishing of a detailed operations and maintenance manual for each appropriate unit of the supplied Goods; d. performance or supervision or maintenance and/or repair of the supplied Goods, for a period of time agreed by the parties, provided that this service shall not relieve the Supplier of any warranty obligations under this Contract; and

- c. training of the Procuring Entity's personnel, at the Supplier's plant and/or on-site, in assembly, start-up, operation, maintenance, and/or repair of the supplied Goods.

The Contract price for the Goods shall include the prices charged by the Supplier for incidental services and shall not exceed the prevailing rates charged to other parties by the Supplier for similar services.

Spare Parts –

The Supplier is required to provide all of the following materials, notifications, and information pertaining to spare parts manufactured or distributed by the Supplier:

- a. such spare parts as the Procuring Entity may elect to purchase from the Supplier, provided that this election shall not relieve the Supplier of any warranty obligations under this Contract; and
- b. in the event of termination of production of the spare parts:
 - i. advance notification to the Procuring Entity of the pending termination, in sufficient time to permit the Procuring Entity to procure needed requirements; and
 - ii. following such termination, furnishing at no cost to the Procuring Entity, the blueprints, drawings, and specifications of the spare parts, if requested.

The spare parts and other components required are listed in Section VI (Schedule of Requirements) and the costs thereof are included in the contract price.

The Supplier shall carry sufficient inventories to assure ex-stock supply of consumable spare parts or components for the Goods for a period of *[Five (5) years]*.

Spare parts or components shall be supplied as promptly as possible, but in any case, within *[Five (5) years]* of placing the order.

	<p>Packaging –</p> <p>The Supplier shall provide such packaging of the Goods as is required to prevent their damage or deterioration during transit to their final destination, as indicated in this Contract. The packaging shall be sufficient to withstand, without limitation, rough handling during transit and exposure to extreme temperatures, salt and precipitation during transit, and open storage. Packaging case size and weights shall take into consideration, where appropriate, the remoteness of the Goods' final destination and the absence of heavy handling facilities at all points in transit.</p> <p>The packaging, marking, and documentation within and outside the packages shall comply strictly with such special requirements as shall be expressly provided for in the Contract, including additional requirements, if any, specified below, and in any subsequent instructions ordered by the Procuring Entity.</p> <p>The outer packaging must be clearly marked on at least four (4) sides as follows:</p> <ul style="list-style-type: none"> Name of the Procuring Entity Name of the Supplier Contract Description Final Destination Gross weight Any special lifting instructions Any special handling instructions Any relevant HAZCHEM classifications
	<p>A packaging list identifying the contents and quantities of the package is to be placed on an accessible point of the outer packaging if practical. If not practical the packaging list is to be placed inside the outer packaging but outside the secondary packaging.</p> <p>Transportation –</p> <p>Where the Supplier is required under Contract to deliver the Goods CIF, CIP, or DDP, transport of the Goods to the port of destination or such other named place of destination in the Philippines, as shall be specified in this Contract, shall be arranged and paid for by the Supplier, and the cost thereof shall be included in the Contract Price.</p> <p>Where the Supplier is required under this Contract to transport the Goods to a specified place of destination within the Philippines, defined as the Project Site, transport to such place of destination in the Philippines, including insurance and storage, as shall be specified in this Contract, shall be arranged by the Supplier, and related costs shall be included in the contract price.</p>

	<p>Where the Supplier is required under Contract to deliver the Goods CIF, CIP or DDP, Goods are to be transported on carriers of Philippine registry. In the event that no carrier of Philippine registry is available, Goods may be shipped by a carrier which is not of Philippine registry provided that the Supplier obtains and presents to the Procuring Entity certification to this effect from the nearest Philippine consulate to the port of dispatch. In the event that carriers of Philippine registry are available but their schedule delays the Supplier in its performance of this Contract the period from when the Goods were first ready for shipment and the actual date of shipment the period of delay will be considered force majeure.</p> <p>The Procuring Entity accepts no liability for the damage of Goods during transit other than those prescribed by INCOTERMS for DDP deliveries. In the case of Goods supplied from within the Philippines or supplied by domestic Suppliers risk and title will not be deemed to have passed to the Procuring Entity until their receipt and final acceptance at the final destination.</p> <p>Intellectual Property Rights –</p> <p>The Supplier shall indemnify the Procuring Entity against all third-party claims of infringement of patent, trademark, or industrial design rights arising from use of the Goods or any part thereof.</p>
<p>2.2</p>	<p><i>"The terms of payment shall be as follows: 30 days."</i></p>
<p>4</p>	<p>The inspections and tests that will be conducted are;</p> <ul style="list-style-type: none"> ▪ Functionality Tests

Section VI. Schedule of Requirements

The delivery schedule expressed as weeks/months stipulates hereafter a delivery date which is the date of delivery to the project site.

Item Number	Description	Quantity	Total	Delivered, Weeks/Months
I	SUPPLY, INSTALLATION, TESTING AND COMMISSIONING OF DIESEL FIRE PUMP			<i>On or before 10 November 2023</i>
II	CONSTRUCTION OF PUMPHOUSE, EQUIPMENT CONCRETE FOUNDATION & INTERCONNECTION OF B.I. PIPES	1 Lot	PHP2,000,000.00	

Section VII
Technical Specifications

**Conformity with the Technical Specifications - 1
(Scope of Works)**

Items	Scope of Works	Supplier's Data and Statement of Compliance
1	Concrete works and reinforcement of fire pump foundation including anchor bolts;	
a	Installation of base plate.	
2	Installation of brand-new Diesel Fire Pump Assembly (Engine with Pump)	
a	Mounting of Diesel Fire Pump Assembly to the metal base plate;	
b	Mechanical alignment of Pump & Engine (Vertical/Horizontal).	
c	Connection of Pipe Spool (Inlet/Discharge);	
d	Welding & connection of 3 in ØSched 40 B.L pipe and tapping;	
e	Installation & set-up of Panel Controller (Manual Start/Stop Button).	
3	Construction of Pumphouse.	
4	Conduct Line integrity, leak test and safety check.	
5	Testing and Commissioning of Diesel Fire Pump	

Name of Bidder: _____

Signature(s) of Bidder: _____

A

**Conformity with the Technical Specifications - 2
(Administrative and Documentary Requirements)**

Item	Description	NPC Requirements	Supplier's Data and Statement of Compliance
1	Warranty	One (1) year reckoned from the date of final acceptance	
2	After-sales support on spare parts	Five (5) years after the warranty period	
3	Delivery/completion date	On or before 10 November 2023	
4	Delivery point	Central Warehouse, BarangayDitucalan, Iligan City	
5	<p>Authority to Bid or Letter of confirmation from the assembler of <u>Diesel Fire Pump</u> that a local agent or representative is available to provide "After Sales Service" to the supplied Components /parts / accessories during and after the warranty period. Name, address and contact number shall be provided.</p>	<p>Submit the authority to bid or letter of confirmation as part of the eligibility requirements (To be included in Technical component envelope) coming from:</p> <ol style="list-style-type: none"> 1. The Original Equipment Manufacturer (OEM) or its Philippine Subsidiary, or 2. Authorized Product Distributor. In this case, the bidder shall also submit the Distributorship Agreement (DA) between the manufacturer and the said authorized distributor. The DA must also indicate that the distributor is vested with authority to distribute the product in the Philippines. 3. If the bidder is an Authorized Distributor in the Philippines, submission of its DA with OEM in lieu of the required authority to bid will suffice. <p>The submitted Authority to Bid and Distributorship Agreements should indicate the validity period and must still be valid during the opening of bids.</p>	

h

Item	Description	NPC Requirements	Supplier's Data and Statement of Compliance
6	Manpower requirements:	<p>Submit Copy of Valid license / Certificate as part of eligibility requirements (To be included in Technical Component Envelope) for</p> <ul style="list-style-type: none"> a. One (1) Professional Mechanical Engineer- Valid PRC License b. One (1) Registered Mechanical Engineer- Valid PRC License c. One (1) Safety Officer- BOSH/COSH Certificate from DOLE accredited Training Institute d. One (1) Millwright/ Mechanic- NCII Certificate from TESDA or TESDA accredited Training Institute e. One (1) Welder- NCII Certificate from TESDA or TESDA accredited Training Institute <p>Submit Copy of Work Experience (To be included in Technical Component Envelope)</p> <ul style="list-style-type: none"> a. Registered Mechanical Engineer- With at least five (5) years of experience as a Mechanical Engineer b. Safety Officer - With at least five (5) years of experience as a Safety Officer c. Millwright/ Mechanic - With at least three (3) years of experience as Millwright or Mechanic d. Welder- With at least three (3) years of experience as welder 	
7	Safety Data Sheet (NOT APPLICABLE)	Submit the Safety Data Sheet (SDS) part of the eligibility requirements (To be included in Technical Component Envelope)	

h

Item	Description	NPC Requirements	Supplier's Data and Statement of Compliance
8	Evidence to support compliance to required Technical Specification	Submit the manufacturer's un-amended sales literature, unconditional statements of specification and compliance issued by the manufacturer, samples, independent test data etc., as appropriate of; 1. Diesel Fire Pump Assembly (complete with specification details of engine and pump) as evidence of the compliance to the required Technical Specifications (To be included in Technical Component Envelope)	
9	Site inspection to be conducted by Competent Technical Personnel related to the project	Submit the Site Inspection Certificate signed by the Authorized NPC representative as part of Post Qualification requirements	
10	Other administrative and / or documentary requirements	None	

Name of Bidder: _____

Signature(s) of Bidder: _____

h

Conformity with the Technical Specifications - 3

1. *Bidders must state here either "Comply" or "Not Comply" against each of the individual parameters of each Specification stating the corresponding performance parameter of the equipment offered.*
2. *Statements of "Comply" or "Not Comply" must be supported by evidence in a Bidders Bid and cross-referenced to that evidence (Under Supplier's Data and Statement of Compliance and after each specification statement, provide guide for the evaluation, such as page number and/or part number, model number where declared specification(s) is found as evidence). Evidence shall be in the form of manufacturer's un-amended sales literature, unconditional statements of specification and compliance issued by the manufacturer, samples, independent test data etc., as appropriate. A statement that is not supported by evidence or is subsequently found to be contradicted by the evidence presented will render the Bid under evaluation liable for rejection. A statement either in the Bidder's statement of compliance or the supporting evidence that is found to be false either during Bid evaluation, post-qualification or the execution of the Contract may be regarded as fraudulent and render the Bidder or supplier liable for prosecution subject to the applicable laws and issuances.*

Item	Description	NPC Required Specifications	Supplier's Data and Statement of Compliance
I.	DIESEL FIRE PUMP ASSEMBLY		
	Brand Name	As per supplier	
	Model Name	As per supplier	
	Quantity	1 Set	
	Manufacturer's Quality Management System / Certification	ISO 9001 Certified or GB 245-2006 or EN144466 or CE	
	Diesel Fire Pump System Assembler / Integrator / Manufacturer's Website with Product Support	Yes, with Independent Domain and the product offer type can be verified at indicated website	
	Manufacturer's Experience in Diesel Fire Pump System Production	At least Fifteen (15) years experience in production of fire pumps	

h

Item	Description	NPC Required Specifications	Supplier's Data and Statement of Compliance
	Pump specifications:		
	Rated RPM	2950	
	Flowrate	20 L/s at least 91.80 meters head or at least 0.90 MPa	
	Inlet port size	100 mm	
	Outlet port size	100 mm	
	Pump casing	Gray iron	
	Impeller	Cast iron	
	Shaft	Carbon Steel 45 or AISI 4140	
	Prime Move Specifications:		
	Prime mover	Diesel Engine	
	Diesel Engine RPM	To match with the design requirements of the pump RPM	
	Output power of diesel engine	63 kW nominal	
	Diesel engine motorized starting	Yes	
	Control voltage	12 Volts	
	Type	Vertical, in-line, water-cooled, four-stroke, Direct Injection	
	No. of cylinder	Four (4)	
	Displacement (L)	3.432 typical	
	Cylinder liner type	WET	
	Intake way	Natural intake /aspiration	
	Torque capability	211 Nm	

SECTION VII – TECHNICAL SPECIFICATION

PR NO./REF. NO, MG-ST523-011

Item	Description	NPC Required Specifications	Supplier's Data and Statement of Compliance
	Accessories:		
	Gate Valve	DN 100	
	Check Valve	DN 100	
	Pressure Relief Valves	DN 15	
	Pressure Switch	Designed for the Nominal Operation Diesel Fire Pump Settable DN 100	
	Manifold pipe for suction	DN 100	
	Diesel Fire Pump Controller (Manual Start/Stop) Remote trigger	Yes	
II.	Pump house & Concrete Foundation:	As per lot (refer to attached drawings for the design and specifications)	
III.	Provide all necessary materials for the successful implementation of the project.	Yes	

Name of Bidder: _____

Signature(s) of Bidder: _____

h



PROJECT TITLE: _____

PREPARED BY:	CHECKED	DATE
CAD		
ARCHIT.		
CIVIL		
MECH.		
ELECTR.		

SUBMITTED BY: _____

RECOMMENDED BY: _____

APPROVED BY: _____

LOCATION: NPC MINGEN, BRNO, MORAVIA CZECHIA, 602 001

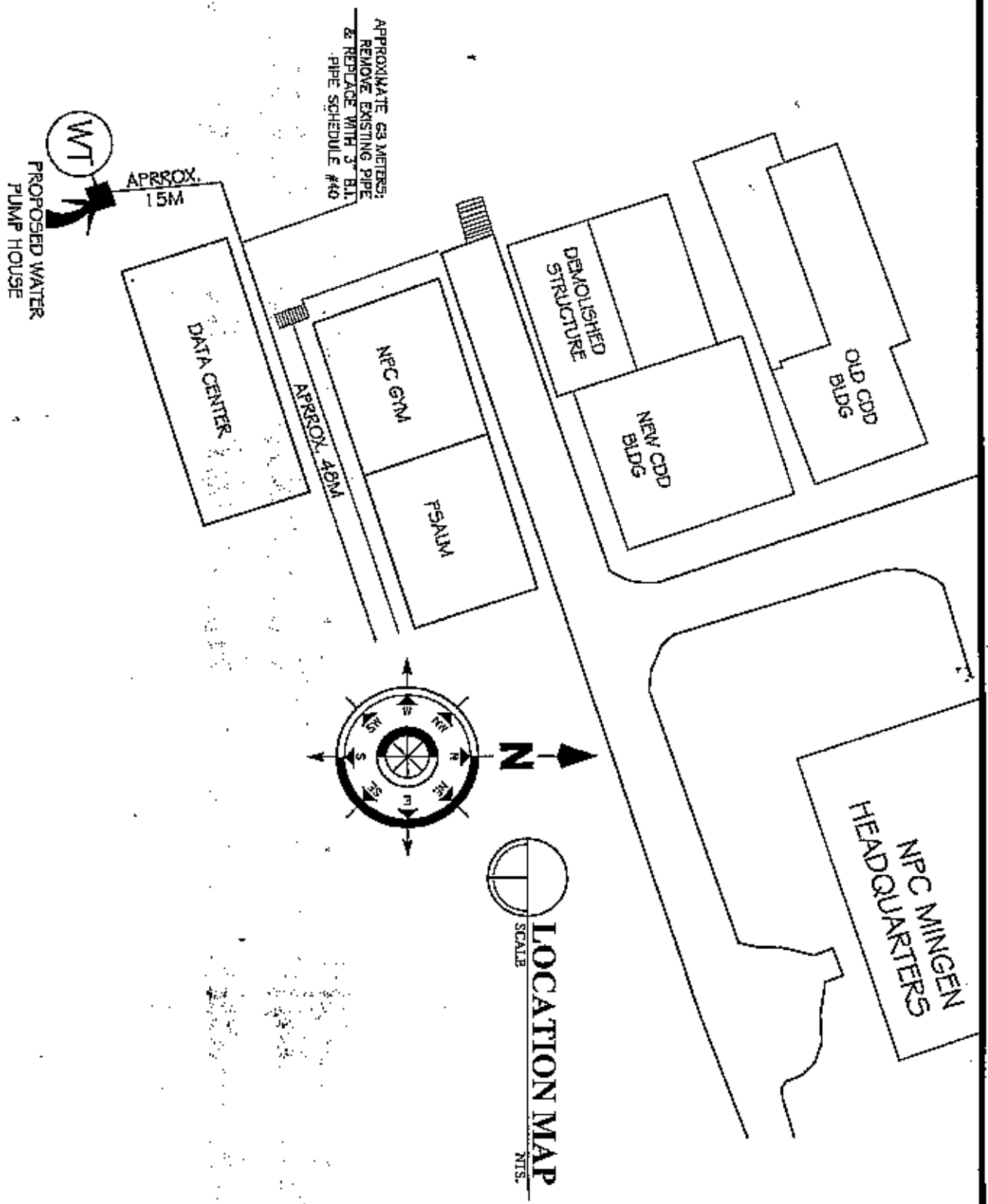



PROJECT TITLE:

PREPARED BY:

CHECKED:

DATE:

SUBMITTED BY:

RECOMMENDED BY:

APPROVED BY:

CAD	
ARCHT	
CIVIL	
MECHL	
ELECT	

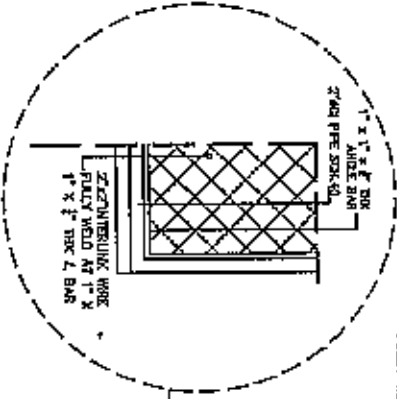

SIDE ELEVATION
SCALE: 1/8" = 1'-0"

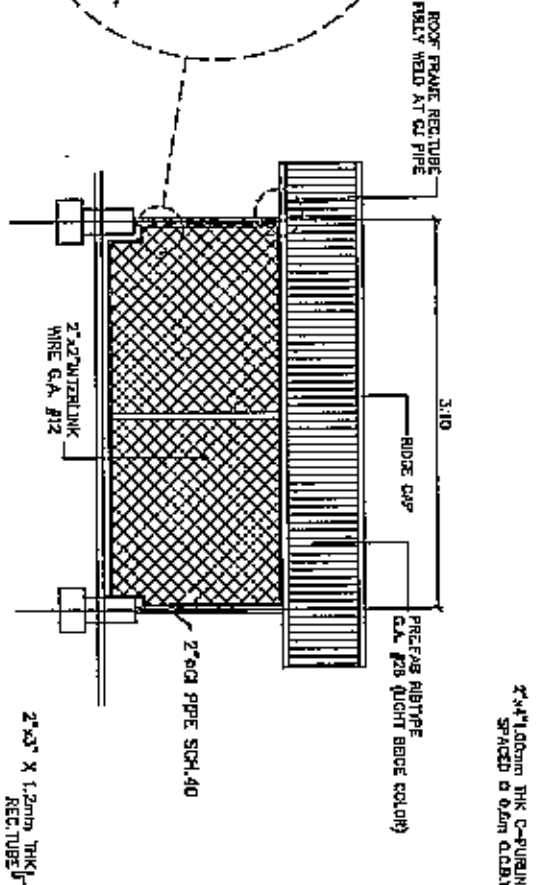

ROOF PLAN
SCALE: 1/8" = 1'-0"

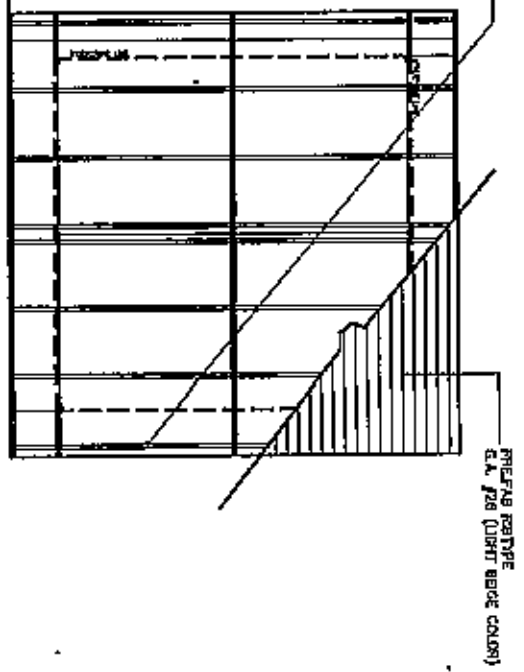

FRONT ELEVATION
SCALE: 1/8" = 1'-0"

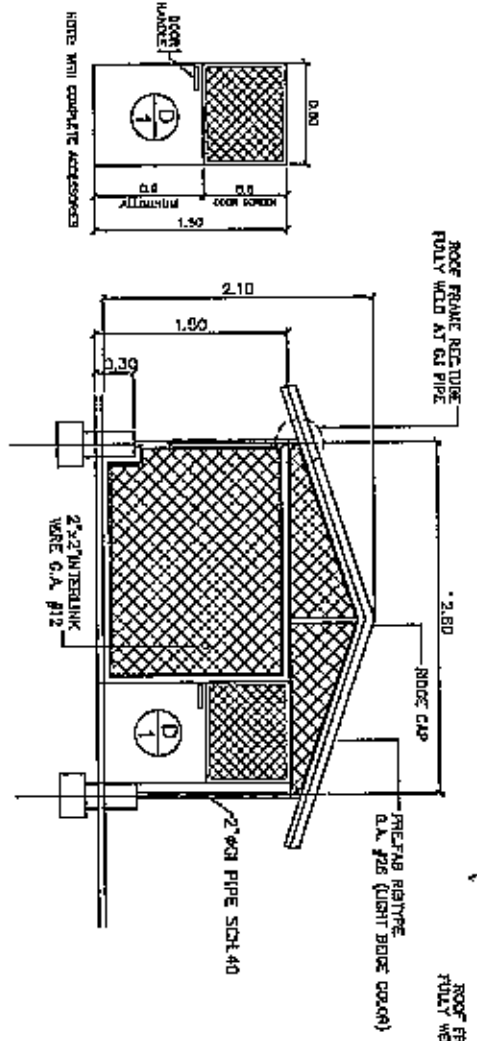

REAR ELEVATION
SCALE: 1/8" = 1'-0"

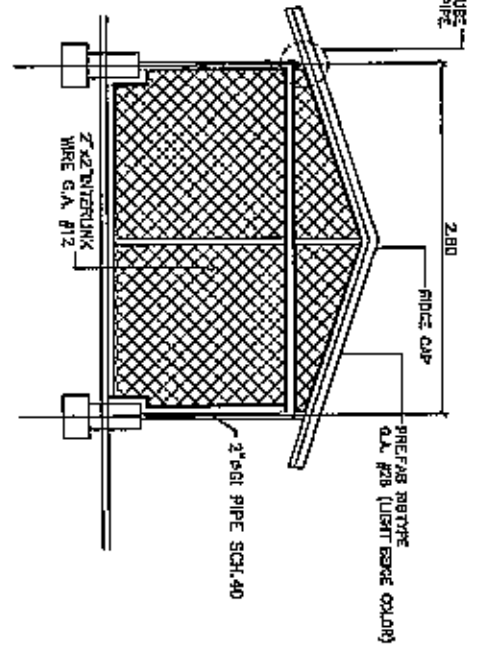

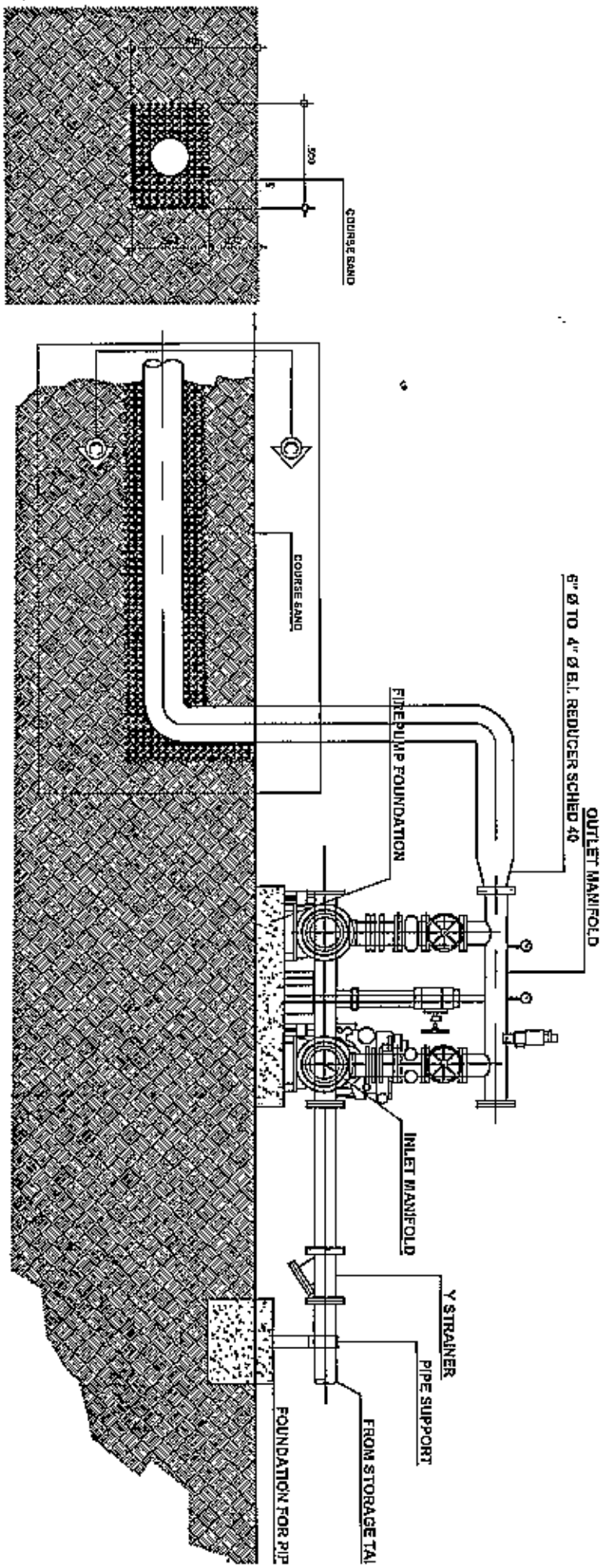

VENT THRU C-C

PROJECT TITLE:		PREPARED BY:		CHECKED:		DATE:		SUBMITTED BY:		RECOMMENDED BY:		APPROVED BY:	
		CAD											
		ARCHT.											
		CIVIL											
		MIRCHL.											
		ELECT.											



CIDD
KOPARSAWALI, WIRALIMINGEN, DEWY, MARVA CRISTINA, WUDAM, CTV

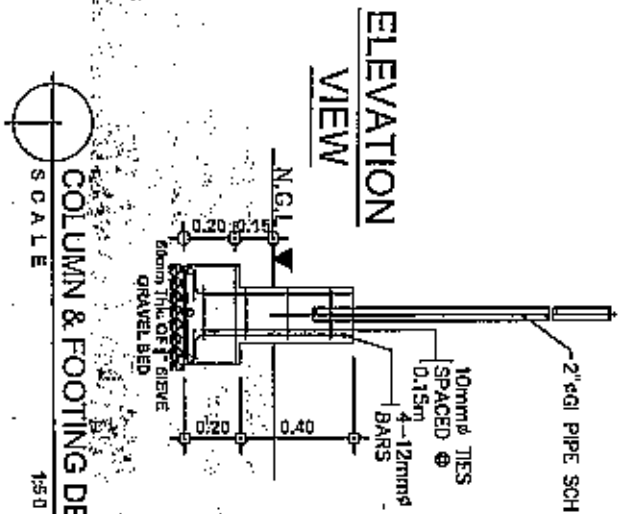
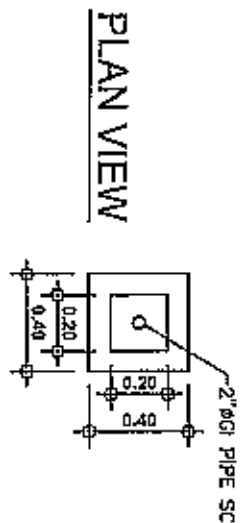
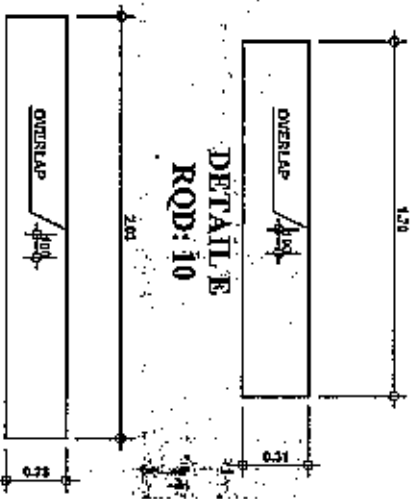
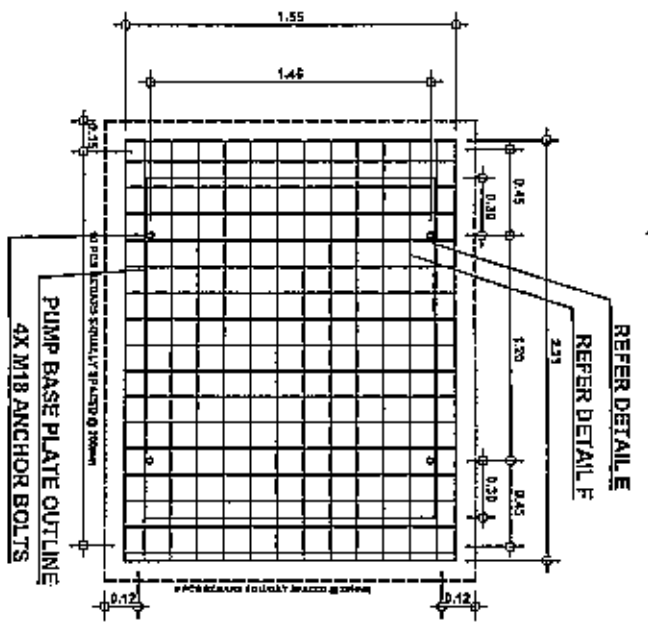
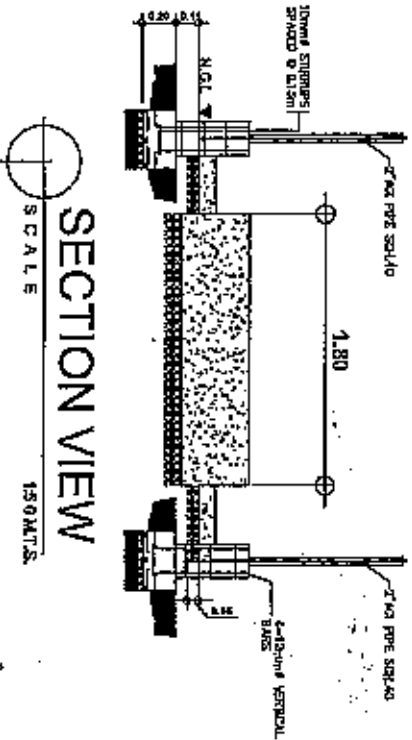
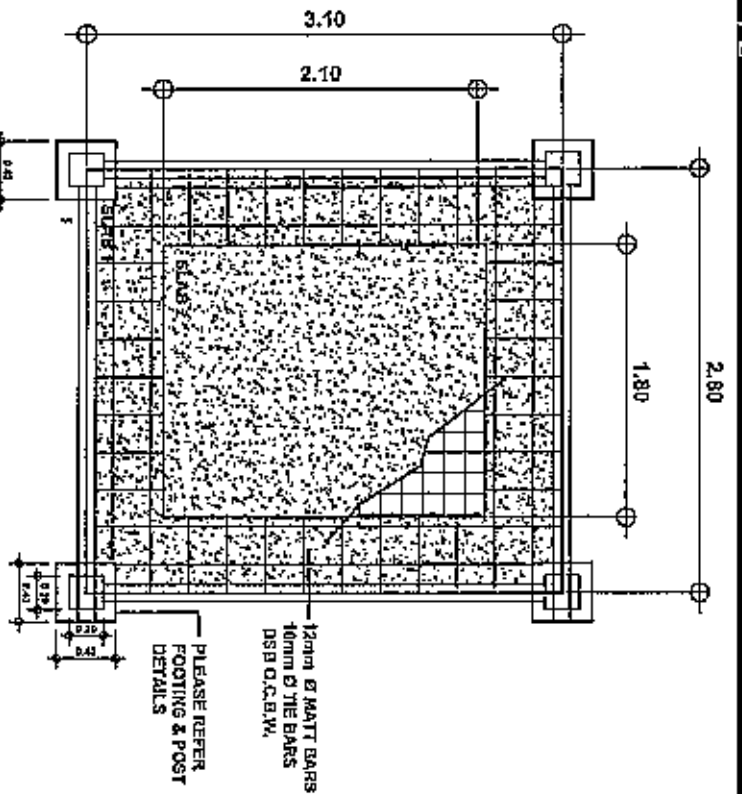

PROJECT TITLE: _____

PREPARED BY:	CAD
CHECKED	ARCHIT.
DATE	CIVIL
SUBMITTED BY:	MECHIL.
	ELECT.

RECOMMENDED BY: _____

APPROVED BY: _____

LOCATION: _____

Section VIII. Checklist of Technical and Financial Documents

Checklist of Technical and Financial Documents

- I. TECHNICAL COMPONENT ENVELOPE/*Submit in three (3) copies- one (1) marked Original with the understanding that the Pass/Fail evaluation will be based only on the copy marked "Original"*

Class "A" Documents

Legal Documents

- (a) Valid and Updated PhilGEPS Registration Certificate (Platinum Membership) (all pages)*in accordance with Section 8.5.2 of the IRR;*
and

Technical Documents

- (b) Statement of the prospective bidder of all its ongoing government and private contracts, including contracts awarded but not yet started, if any, whether similar or not similar in nature and complexity to the contract to be bid *using NPC form NPCSF-GOODS-002 Form G;* and

- (c) Statement of the bidder's Single Largest Completed Contract (SLCC) similar to the contract to be bid, except under conditions provided for in Sections 23.4.1.3 and 23.4.2.4 of the 2016 revised IRR of RA No. 9184, within the relevant period as provided in the Bidding Documents *using NPC form NPCSF-GOODS-003 Form F* supported by the following documents:

- i. Purchase Order or Contract
- ii. Proof of Payment and/or Certificate of Acceptance

- and
 (d) Original copy of Bid Security. If in the form of a Surety Bond, submit also a certification issued by the Insurance Commission;

or
Original copy of Notarized Bid Securing Declaration; and

- (e) Conformity with the Technical Specifications 1, 2 and 3 (refer to Section VII for documentary eligibility requirements), which may include production/delivery schedule, manpower requirements, and/or after-sales/parts, if applicable; and

SECTION VIII - CHECKLIST OF TECH. AND FINAN DOCS AND BIDDING FORMS PR NO./REF. NO.MG-STS23-011

- (f) Original duly signed Omnibus Sworn Statement (OSS); and if applicable, Original Notarized Secretary's Certificate in case of a corporation, partnership, or cooperative; or Original Special Power of Attorney of all members of the joint venture giving full power and authority to its officer to sign the OSS and do acts to represent the Bidder; and

Financial Documents

- (g) The prospective bidder's computation of Net Financial Contracting Capacity (NFCC); or
A committed Line of Credit from a Universal or Commercial Bank in lieu of its NFCC computation.

Class "B" Documents

- (h) If applicable, a duly signed joint venture agreement (JVA) in case the joint venture is already in existence; or
duly notarized statements from all the potential joint venture partners stating that they will enter into and abide by the provisions of the JVA in the instance that the bid is successful.

Other documentary requirements under RA No. 9184 (as applicable)

- (i) *[For foreign bidders claiming by reason of their country's extension of reciprocal rights to Filipinos]* Certification from the relevant government office of their country stating that Filipinos are allowed to participate in government procurement activities for the same item or product.
- (j) Certification from the DTI if the Bidder claims preference as a Domestic Bidder or Domestic Entity.

II. FINANCIAL COMPONENT ENVELOPE*[Submit in three (3) copies- one (1) marked Original with the understanding that the Pass/Fail evaluation will be based only on the copy marked "Original"]*

- (a) Original of accomplished and duly signed (each and every page) Financial Bid Form; and
- (b) Original of accomplished and duly signed (each and every page) Price Schedule(s).

REFERENCE NO.	Description:
---------------	--------------

List of all Ongoing Government & Private Contracts including contracts awarded but not yet started

Business Name :

Business Address :

Name of Contract/ Project cost	a. Owner's Name b. Address c. Telephone Nos.	Nature of Work	Bidder's Role		a. Date Awarded b. Date Started c. Date of Completion	% of Accomplishment		Value of Outstanding Works / Undelivered Portion
			Description	%		Planned	Actual	
Government								
Private								
						Total Cost		

Submitted by _____

(Printed Name & Signature)

Designation _____
Date _____

Designation _____
Date _____

NPCSR-GOODS -03

REFERENCE NO.	Description:
----------------------	---------------------

Statement of all Government & Private Contracts completed which are similar in nature

Business Name :

Business Address :

Name of Contract	a. Owner's Name b. Address c. Telephone Nos.	Nature of Work	Bidder's Role		a. Amount of Award b. Amount of Completion c. Duration	a. Date Awarded b. Contract Effectivity c. Date Completed
			Description	%		
<u>Government</u>						
<u>Private</u>						

Note: This statement shall be supported with:
 1. Purchase Order / Contract
 2. Certificate of Acceptance and/or Proof of Payment

Submitted by : _____
 (Printed Name & Signature)

Designation : _____
 Date : _____

This statement will show that the value of the prospective bidder's largest single completed contract, adjusted to current prices using the National Statistics Office (NSO) consumer price indices available at the G-EPIS website, and similar to the contract to be bid, must be at least fifty percent (50%) of the approved budget for the contract to be bid

STATEMENT OF NFCC COMPUTATION

Date: _____

THE BAC CHAIRMAN
Mindanao Generation, HQ
National Power Corporation
Maria Cristina, Iligan City

CONTACT/PROJECT : _____

 COMPANY/FIRM : _____
 ADDRESS : _____

The undersigned, duly authorized representative of the Applicant, for and in behalf of the Bidder hereby submits this statement of Net Financial Contracting Capacity (NFCC) in relation with the Application for Eligibility to bid for the (Name of the Contract/Project):

CURRENT ASSETS	P	_____
LESS: CURRENT LIABILITIES		_____
NET CURRENT ASSETS	P	_____
Multiply by"		_____ 15
	P	_____
Less: Value of On-going Contracts & Awarded contracts yet to be started		_____
NFCC	P	=====

Name of Authorized Signatory: _____

Signature : _____

(SAMPLE)

JOINT VENTURE AGREEMENT

KNOWN ALL MEN BY THESE PRESENTS:

That this JOINT VENTURE AGREEMENT is entered into by and between

(NAME OF LEAD COMPANY), represented by (NAME OF REPRESENTATIVE), of legal age, married, owner and a resident of (COMPLETE ADDRESS), appointed as the lawful attorney-in-fact and lead company to sign the contract if awarded the project.

- and -

(NAME OF THE OTHER COMPANY), represented by (NAME OF REPRESENTATIVE), of legal age, married, owner and a resident of (COMPLETE ADDRESS) represents as member/principal of the Joint Venture.

That both parties agreed to join together their manpower, equipment and resources needed to facilitate the Joint Venture to participate in the bidding and undertaking of the here-under stated project to be conducted by the NATIONAL POWER CORPORATION, (Plant/location of the project)

NAME OF PROJECT

APPROVED BUDGET FOR THE CONTRACT

P _____

That both parties agreed that, (NAME OF LEAD COMPANY), shall be the official representative and/or lead of the Joint Venture; and is granted full power and authority to do, execute and perform any and all acts necessary and/or to represent the Joint Venture in the bidding as fully and effectively and the Joint Venture may do and if personally present with full power of substitution and revocation.

That this Joint Venture Agreement shall remain in effect only for the above stated project until terminated by both parties.

That both parties hereby bind themselves jointly and severally liable to the National Power Corporation in the prosecution of the above-named undertaking.

(Signature over printed name of representative)
(Designation)
(Name of lead company)

(Signature over printed name of representative)
(Designation)
(Name of the other company)

SIGNED IN THE PRESENCE OF

SECTION VIII- CHECKLIST OF TECH. AND FINAN DOCS AND BIDDING FORMS PR NO./REF. NO: MG-ST23-011
ACKNOWLEDGMENT

REPUBLIC OF THE PHILIPPINES)
_____ City)

Before me,

All known to me and known to be the same person

WITNESS MY HAND SEAL on the date and place stated above.

Doc No. _____
Page no. _____
Book No. _____
Series of (Year) _____

(NOTARY PUBLIC)

MARC MINGUEL

FORM OF BID SECURITY (BANK GUARANTEE)

WHEREAS, *(Name of Bidder)* _____ (hereinafter called "the Bidder" has submitted his bid dated *(Date)* _____ for the *(Name of Project)* (hereinafter called "the Bid").

KNOW ALL MEN by these presents that We *(Name of Bank)* _____ of *(Name of Country)* _____ having our registered office at _____ (hereinafter called "the Bank" are bound unto National Power Corporation (hereinafter called "the Entity") in the sum of *(amount in words & figures as prescribed in the bidding documents)* for which payment well and truly to be made to the said Entity the Bank binds himself, his successors and assigns by these presents.

SEALED with Common Seal of the said Bank this _____ day of _____ 20 _____

THE CONDITIONS of this obligation are that:

- 1) If the Bidder withdraws his Bid during the period of bid validity specified in the Bidding documents; or
- 2) if the Bidder does not accept the correction of arithmetical errors of his bid price in accordance with the instructions to Bidder; or
- 3) if the Bidder, having determined as the LCB, fails or refuses to submit the required tax clearance, latest income and business tax returns and PhilGEPS registration certificate within the prescribed period; or
- 4) if the Bidder having been notified of the acceptance of his bid and award of contract to him by the Entity during the period of bid validity:
 - a) fails or refuses to execute the Contract; or
 - b) fails or refuses to submit the required valid JVA, if applicable; or
 - c) fails or refuses to furnish the Performance Security in accordance with the instructions to Bidders;

We undertake to pay to the Entity up to the above amount upon receipt of his first written demand, without the Entity having to substantiate its demand, provided that in his demand the Entity will note that the amount claimed by it is due to the occurrence of any one or combination of the four(4) conditions stated above.

The Guarantee will remain in force up to 120 days after the opening of bids or as it may be extended by the Entity, notice of which extension (s) to the Bank is hereby waived. Any demand in respect of this Guarantee should reach the Bank not later than the above date.

DATE _____ SIGNATURE OF THE BANK _____

WITNESS _____ SEAL _____

(Signature, Name and Address)

FORM OF BID SECURITY (SURETY BOND)

By this bond, We, (Name of Bidder) (hereinafter called "the Principal") and (Name of Surety) of (Name of Country of Surety), authorized to transact business in the Philippines (hereinafter called "the Surety") are held and firmly bound unto National Power Corporation (hereinafter called "the Employer") as Oblige, in the sum of (amount in words & figures as prescribed in the bidding documents), callable on demand, for the payment of which sum, well and truly to be made, we, the said Principal and Surety bind ourselves, our successors and assigns, jointly and severally, firmly by these presents.

SEALED with our seals and dated this _____ day of _____ 20 _____

WHEREAS, the Principal has submitted a written Bid to the Employer dated the _____ day of _____ 20 _____, for the _____ (hereinafter called "the Bid").

NOW, THEREFORE, the conditions of this obligation are:

- 1) if the Bidder withdraws his Bid during the period of bid validity specified in the Bidding Documents; or
- 2) if the Bidder does not accept the correction of arithmetical errors of his bid price in accordance with the Instructions to Bidder; or
- 3) if the Bidder, having determined as the LCB, fails or refuses to submit the required tax clearance, latest income and business tax returns and PhilGEP's registration certificate within the prescribed period; or
- 4) if the Bidder having been notified of the acceptance of his bid and award to contract to him by the Entity during the period of bid validity:
 - d) fails or refuses to execute the Contract; or
 - e) fails or refuses to submit the required valid JVA, if applicable; or
 - f) fails or refuses to furnish the Performance Security in accordance with the Instructions to bidders;

then this obligation shall remain in full force and effect, otherwise it shall be null and void.

PROVIDED HOWEVER, that the Surety shall not be:

- a) liable for a greater sum than the specified penalty of this bond, nor
- b) liable for a greater sum than the difference between the amount of the said Principal's Bid and the amount of the Bid that is accepted by the Employer.

This Surety executing this instrument hereby agrees that its obligation shall be valid for 120 Calendar days after the deadline for submission of Bids as such deadline is stated in the instructions to Bidders or as it may be extended by the Employer, notice of which extension (s) to the Surety is hereby waived.

PRINCIPAL _____

SURETY _____

SIGNATURE (S) _____

SIGNATURE (S) _____

NAME (S) AND TITLE (S) _____

NAME (S) _____

SEAL _____

SEAL _____

NPC-MINGEN

Bid Securing Declaration Form

[shall be submitted with the Bid if bidder opts to provide this form of bid security]

REPUBLIC OF THE PHILIPPINES)
CITY OF _____) S.S.

BID SECURING DECLARATION
Project Identification No.: [Insert number]

To: *[Insert name and address of the Procuring Entity]*

I/We, the undersigned, declare that:

1. I/We understand that, according to your conditions, bids must be supported by a Bid Security, which may be in the form of a Bid Securing Declaration.
2. I/We accept that: (a) I/we will be automatically disqualified from bidding for any procurement contract with any procuring entity for a period of two (2) years upon receipt of your Blacklisting Order; and, (b) I/we will pay the applicable fine provided under Section 6 of the Guidelines on the Use of Bid Securing Declaration, within fifteen (15) days from receipt of the written demand by the procuring entity for the commission of acts resulting to the enforcement of the bid securing declaration under Sections 23.1(b), 34.2, 40.1 and 69.1, except 69.1(f), of the IRR of RA No. 9184; without prejudice to other legal action the government may undertake.
3. I/We understand that this Bid Securing Declaration shall cease to be valid on the following circumstances:
 - a. Upon expiration of the bid validity period, or any extension thereof pursuant to your request;
 - b. I am/we are declared ineligible or post-disqualified upon receipt of your notice to such effect, and (i) I/we failed to timely file a request for reconsideration or (ii) I/we filed a waiver to avail of said right; and
 - c. I am/we are declared the bidder with the Lowest Calculated Responsive Bid, and I/we have furnished the performance security and signed the Contract.

IN WITNESS WHEREOF, I/We have hereunto set my/our hand/s this ____ day of [month] [year] at [place of execution].

[Insert NAME OF BIDDER OR ITS AUTHORIZED REPRESENTATIVE]

[Insert signatory's legal capacity]

Affiant

[Jurat]

[Format shall be based on the latest Rules on Notarial Practice].

Omnibus Sworn Statement (Revised)

SECTION VIII- CHECKLIST OF TECH. AND FINAN DOCS AND BIDDING FORMS PR NO./REF. NO.: MG-ST23-011
*[shall be submitted with the Bid]*REPUBLIC OF THE PHILIPPINES)
CITY/MUNICIPALITY OF _____) S.S.

AFFIDAVIT

I, [Name of Affiant], of legal age, [Civil Status], [Nationality], and residing at [Address of Affiant], after having been duly sworn in accordance with law, do hereby depose and state that:

1. *[Select one, delete the other:]*

[If a sole proprietorship:] I am the sole proprietor or authorized representative of [Name of Bidder] with office address at [address of Bidder];

[If a partnership, corporation, cooperative, or joint venture:] I am the duly authorized and designated representative of [Name of Bidder] with office address at [address of Bidder];

2. *[Select one, delete the other:]*

[If a sole proprietorship:] As the owner and sole proprietor, or authorized representative of [Name of Bidder], I have full power and authority to do, execute and perform any and all acts necessary to participate, submit the bid, and to sign and execute the ensuing contract for [Name of the Project] of the [Name of the Procuring Entity], as shown in the attached duly notarized Special Power of Attorney;

[If a partnership, corporation, cooperative, or joint venture:] I am granted full power and authority to do, execute and perform any and all acts necessary to participate, submit the bid, and to sign and execute the ensuing contract for [Name of the Project] of the [Name of the Procuring Entity], as shown in the attached [state title of attached document showing proof of authorization (e.g., duly notarized Secretary's Certificate, Board/Partnership Resolution, or Special Power of Attorney, whichever is applicable)];

3. [Name of Bidder] is not "blacklisted" or barred from bidding by the Government of the Philippines or any of its agencies, offices, corporations, or Local Government Units, foreign government/foreign or international financing institution whose blacklisting rules have been recognized by the Government Procurement Policy Board, by itself or by relation, membership, association, affiliation, or controlling interest with another blacklisted person or entity as defined and provided for in the Uniform Guidelines on Blacklisting;
4. Each of the documents submitted in satisfaction of the bidding requirements is an authentic copy of the original, complete, and all statements and information provided therein are true and correct;
5. [Name of Bidder] is authorizing the Head of the Procuring Entity or its duly authorized representative(s) to verify all the documents submitted;

6. *[Select one, delete the rest:]*

[If a sole proprietorship:] The owner or sole proprietor is not related to the Head of the Procuring Entity, members of the Bids and Awards Committee (BAC), the Technical Working Group, and the BAC Secretariat, the head of the Project Management Office or the end-user unit, and the project consultants by consanguinity or affinity up to the third civil degree;

[If a partnership or cooperative:] None of the officers and members of *[Name of Bidder]* is related to the Head of the Procuring Entity, members of the Bids and Awards Committee (BAC), the Technical Working Group, and the BAC Secretariat, the head of the Project Management Office or the end-user unit, and the project consultants by consanguinity or affinity up to the third civil degree;

*[If a corporation or joint venture:]*None of the officers, directors, and controlling stockholders of *[Name of Bidder]* is related to the Head of the Procuring Entity, members of the Bids and Awards Committee (BAC), the Technical Working Group, and the BAC Secretariat, the head of the Project Management Office or the end-user unit, and the project consultants by consanguinity or affinity up to the third civil degree;

7. *[Name of Bidder]* complies with existing labor laws and standards; and
8. *[Name of Bidder]* is aware of and has undertaken the responsibilities as a Bidder in compliance with the Philippine Bidding Documents, which includes:
 - a. Carefully examining all of the Bidding Documents;
 - b. Acknowledging all conditions, local or otherwise, affecting the implementation of the Contract;
 - c. Making an estimate of the facilities available and needed for the contract to be bid, if any; and
 - d. Inquiring or securing Supplemental/Bid Bulletin(s) issued for the *[Name of the Project]*.
9. *[Name of Bidder]* did not give or pay directly or indirectly, any commission, amount, fee, or any form of consideration, pecuniary or otherwise, to any person or official, personnel or representative of the government in relation to any procurement project or activity.
10. In case advance payment was made or given, failure to perform or deliver any of the obligations and undertakings in the contract shall be sufficient grounds to constitute criminal liability for Swindling (Estafa) or the commission of fraud with unfaithfulness or abuse of confidence through misappropriating or converting any payment received by a person or entity under an obligation involving the duty to deliver certain goods or services, to the prejudice of the public and the government of the Philippines pursuant to Article 315 of Act No. 3815 s. 1930, as amended, or the Revised Penal Code.

IN WITNESS WHEREOF, I have hereunto set my hand this ___ day of ___, 20__ at _____, Philippines.

BID DOCUMENTS

NAME OF PROJECT: CONSTRUCTION OF PUMPHOUSE AND
SUPPLY OF FIRE HYDRANT &
FIREFIGHTING SYSTEM

SECTION VIII- CHECKLIST OF TECH. AND FINAN DOCS AND BIDDING FORMS PR NO./REF. NO: .MG-STS23-011

*[Insert NAME OF BIDDER OR ITS AUTHORIZED
REPRESENTATIVE]*

[Insert signatory's legal capacity]

Affiant

[Jurat]

[Format shall be based on the latest Rules on Notarial Practice].

NPC-MINGEN

APPENDIX "1"

Bid Form for the Procurement of Goods
[shall be submitted with the Bid]

BID FORM

Date : _____

Project Identification No. : _____

To: [name and address of Procuring Entity]

Having examined the Philippine Bidding Documents (PBDs) including the Supplemental or Bid Bulletin Numbers [insert numbers], the receipt of which is hereby duly acknowledged, we, the undersigned, offer to [supply/deliver/perform] [description of the Goods] in conformity with the said PBDs for the sum of [total Bid amount in words and figures] or the total calculated bid price, as evaluated and corrected for computational errors, and other bid modifications in accordance with the Price Schedules attached herewith and made part of this Bid. The total bid price includes the cost of all taxes, such as, but not limited to: [specify the applicable taxes, e.g. (i) value added tax (VAT), (ii) income tax, (iii) local taxes, and (iv) other fiscal levies and duties], which are itemized herein or in the Price Schedules,

If our Bid is accepted, we undertake:

- a. to deliver the goods in accordance with the delivery schedule specified in the Schedule of Requirements of the Philippine Bidding Documents (PBDs);
- b. to provide a performance security in the form, amounts, and within the times prescribed in the PBDs;
- c. to abide by the Bid Validity Period specified in the PBDs and it shall remain binding upon us at any time before the expiration of that period.

[Insert this paragraph if Foreign-Assisted Project with the Development Partner: Commissions or gratuities, if any, paid or to be paid by us to agents relating to this Bid, and to contract execution if we are awarded the contract, are listed below:

Name and address of agent	Amount	Purpose of Commission or gratuity
_____	_____	_____
_____	_____	_____

(if none, state "None")]

Until a formal Contract is prepared and executed, this Bid, together with your written acceptance thereof and your Notice of Award, shall be binding upon us.

We understand that you are not bound to accept the Lowest Calculated Bid or any Bid you may receive.

We certify/confirm that we comply with the eligibility requirements pursuant to the PBDs.

The undersigned is authorized to submit the bid on behalf of [name of the bidder] as evidenced by the attached [state the written authority].

SECTION VIII- CHECKLIST OF TECH. AND FINAN DOCS AND BIDDING FORMS PR NO./REF. NO: .MG-STS23-011

We acknowledge that failure to sign each and every page of this Bid Form, including the attached Schedule of Prices, shall be a ground for the rejection of our bid.

Name: _____

Legal capacity: _____

Signature: _____

Duly authorized to sign the Bid for and behalf of: _____

Date: _____

NPC-MINGEN

Performance Securing Declaration (Revised)

[if used as an alternative performance security but it is not required to be submitted with the Bid, as it shall be submitted within ten (10) days after receiving the Notice of Award]

REPUBLIC OF THE PHILIPPINES)
CITY OF _____) S.S.

PERFORMANCE SECURING DECLARATION

Invitation to Bid: [Insert Reference Number indicated in the Bidding Documents]
To: [Insert name and address of the Procuring Entity]

I/We, the undersigned, declare that:

1. I/We understand that, according to your conditions, to guarantee the faithful performance by the supplier/distributor/manufacturer/contractor/consultant of its obligations under the Contract, I/we shall submit a Performance Securing Declaration within a maximum period of ten (10) calendar days from the receipt of the Notice of Award prior to the signing of the Contract.
2. I/We accept that: I/we will be automatically disqualified from bidding for any procurement contract with any procuring entity for a period of one (1) year for the first offense, or two (2) years for the second offense, upon receipt of your Blacklisting Order if I/We have violated my/our obligations under the Contract;
3. I/We understand that this Performance Securing Declaration shall cease to be valid upon:
 - a. issuance by the Procuring Entity of the Certificate of Final Acceptance, subject to the following conditions:
 - i. Procuring Entity has no claims filed against the contract awardee;
 - ii. It has no claims for labor and materials filed against the contractor; and
 - iii. Other terms of the contract; or
 - b. replacement by the winning bidder of the submitted PSD with a performance security in any of the prescribed forms under Section 39.2 of the 2016 revised IRR of RA No. 9184 as required by the end-user.

IN WITNESS WHEREOF, I/We have hereunto set my/our hand/s this ____ day of [month] [year] at [place of execution].

*[Insert NAME OF BIDDER OR ITS
AUTHORIZED REPRESENTATIVE]
[Insert signatory's legal capacity]
Affiant*

[Jurat]
[Format shall be based on the latest Rules on Notarial Practice]

Price Schedule for Goods Offered from Abroad
[shall be submitted with the Bid if bidder is offering goods from Abroad]

For Goods Offered from Abroad

Name of Bidder _____ Project ID No. _____ Page ____ of ____

1	2	3	4	5	6	7	8	9
Item	Description	Country of origin	Quantity	Unit price CIF port of entry (specify port) or CIP named place (specify border point or place of destination)	Total CIF or CIP price per item (col. 4 x 5)	Unit Price Delivered Duty Unpaid (DDU)	Unit price Delivered Duty Paid (DDP)	Total Price delivered DDP (col 4 x 8)

Name: _____

Legal Capacity: _____

Signature: _____

Duly authorized to sign the Bid for and behalf of: _____

Price Schedule for Goods Offered from Within the Philippines
[shall be submitted with the Bid if bidder is offering goods from within the Philippines]

For Goods Offered from Within the Philippines

Name of Bidder _____ Project ID No. _____ Page ___ of ___

1	2	3	4	5	6	7	8	9	10
Item	Description	Country of origin	Quantity	Unit price EXWp or item	Transportation and all other costs incidental to delivery, per item	Sales and other taxes payable if Contract is awarded, per item	Cost of Incidental Services, if applicable, per item	Total Price, per unit (col 4 + 5 + 6 + 7 + 8)	Total Price Delivered Final Destination (col 9) x (col 4)

Name: _____

Legal Capacity: _____

Signature: _____

Duly authorized to sign the Bid for and behalf of: _____

Contract Agreement Form for the Procurement of Goods (Revised)

[Not required to be submitted with the Bid, but it shall be submitted within ten (10) days after receiving the Notice of Award]

CONTRACT AGREEMENT

THIS AGREEMENT made the ____ day of _____, 20____ between [name of PROCURING ENTITY] of the Philippines (hereinafter called "the Entity") of the one part and [name of Supplier] of [city and country of Supplier] (hereinafter called "the Supplier") of the other part;

WHEREAS, the Entity invited Bids for certain goods and ancillary services, particularly [brief description of goods and services] and has accepted a Bid by the Supplier for the supply of those goods and services in the sum of [contract price in words and figures in specified currency] (hereinafter called "the Contract Price").

NOW THIS AGREEMENT WITNESSETH AS FOLLOWS:

1. In this Agreement words and expressions shall have the same meanings as are respectively assigned to them in the Conditions of Contract referred to.
2. The following documents as required by the 2016 revised Implementing Rules and Regulations of Republic Act No. 9184 shall be deemed to form and be read and construed as integral part of this Agreement, viz.:
 - i. Philippine Bidding Documents (PBDs);
 - i. Schedule of Requirements;
 - ii. Technical Specifications;
 - iii. General and Special Conditions of Contract; and
 - iv. Supplemental or Bid Bulletins, if any
 - ii. Winning bidder's bid, including the Eligibility requirements, Technical and Financial Proposals, and all other documents or statements submitted;

Bid form, including all the documents/statements contained in the Bidder's bidding envelopes, as annexes, and all other documents submitted (e.g., Bidder's response to request for clarifications on the bid), including corrections to the bid, if any, resulting from the Procuring Entity's bid evaluation;
 - iii. Performance Security;
 - iv. Notice of Award of Contract; and the Bidder's conforme thereto; and
 - v. Other contract documents that may be required by existing laws and/or the Procuring Entity concerned in the PBDs. Winning bidder agrees that additional contract documents or information prescribed by the GPPB that are subsequently required for submission after the contract execution, such as the Notice to Proceed, Variation Orders, and Warranty Security, shall likewise form part of the Contract.
3. In consideration for the sum of [total contract price in words and figures] or such other sums as may be ascertained, [Name of the bidder] agrees to [state the object of the contract] in accordance with his/her/its Bid.

SECTION VIII- CHECKLIST OF TECH. AND FINAN DOCS AND BIDDING FORMS PR NO./REF. NO: .MG-ST523-011

4. The *[Name of the procuring entity]* agrees to pay the above-mentioned sum in accordance with the terms of the Bidding.

IN WITNESS whereof the parties hereto have caused this Agreement to be executed in accordance with the laws of the Republic of the Philippines on the day and year first above written.

[Insert Name and Signature]

[Insert Name and Signature]

[Insert Signatory's Legal Capacity]

[Insert Signatory's Legal Capacity]

for:

for:

[Insert Procuring Entity]

[Insert Name of Supplier]

Acknowledgment

[Format shall be based on the latest Rules on Notarial Practice]

